

# Kinghelm®

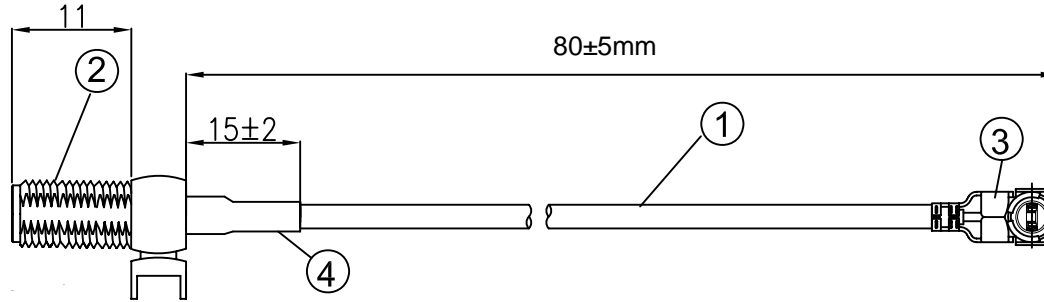

**NOTES:**

1. ELECTRICAL:
  - 1.1. VOLTAGE RATING:DCV 300V 10MS
  - 1.2. CONDUCTANCE RESISTANCE: 3.0 OHM/MAX.
  - 1.3. INSULATION RESISTANCE: 5.0M OHM/MIN.
  - 1.4. THE CABLE SHOULD BE 100% ELECTRICAL TEST
  - 1.5. IT SHOULD BE NO ANY OPEN/SHORT, MISWIRING AND INTERMITTENT FAILURES
2. MATERIAL:
  - 2.1. SEE TABLE
3. ALL COMPONENTS ARE RoHS COMPLIANT.

ITEM NO.	PATR NUMBER	DESCRIPTION	QTY
④	Tube	Black Heat-shrink Tube, OD:2.0MM	AS
③	Terminal	High-quality Copy I-PEX 1.13 Terminal, gold-plating	1
②	Joint	SMA-K, with 4 terminalssplit-type with 11 screws, gold-plating(SMA-K)	1
①	Coaxial Cable	RF 1.13 Black Cable, OD:1.13mm	AS

SHENZHEN KINGHELM ELECTRONIC CO., LTD.

[WWW.BDS666.COM](http://WWW.BDS666.COM)

**KH-IPEX-SMAKWE-Q80H**

**0755-83044319**

ALL DIMENSION ARE IN MM	DRAWN	James	DATE	2020-04-15
	CHKD.	Frank		2020-04-15
COMPUTER GENERATED IN SOLIDWORKS	APPD.	Scott		2020-04-15
DO NOT SCALE THIS DRAWING				

I-PEX 1.13 TO SMA /F L= 80mm

PROJECTION	GENERAL TOLERANCE FOR ANGLES
	X.X X.XX X.XXX ± 1° ± 0.3 ± 0.25 ± 0.150

SIZE	Number	REV
<b>B</b>		<b>A</b>
SCALE: Free	TYPE	SHEET 1 OF 1

CUSTOMER P/N: