

# Kinghelm®

REV.	ECN NO.	DESCRIPTION	DATE	DESIGN
A1.	/.	重新核对图面	21.01.14	LiHui

PIN NUMBER	SIGNAL NAME
PIN 1	Vbus
PIN 2	D-
PIN 3	D+
PIN 4	GND
PIN 5	Std_A_SSRX-
PIN 6	Std_A_SSRX+
PIN 7	GND_DRAIN
PIN 8	Std_A_SSTX-
PIN 9	Std_A_SSTX+
SHELL	GND

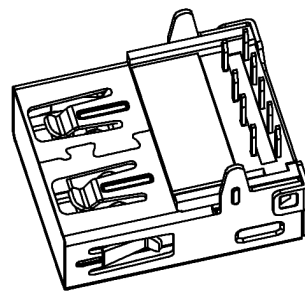

**NOTES:**

- MATERIAL:
  - HOUSING: PBT ,COLOR IS BLUE;
  - CONTACT: BRASS (H65 T=0.20&0.25mm);
  - SHELL: COLD ROLLED IRON (SPCC T=0.30mm);
- ELECTRICAL:
  - VOLTAGE RATING: 30V DC ;
  - CURRENT RATING: 1.5A ;
  - CONTACT RESISTANCE: 30MILLIOHMS MAX.;
  - WITHSTAND VOLTAGE: 100V AC RMS 50(60)Hz,1MIN.;
  - INSULATION RESISTANCE: 100MEGOHMS MIN @500V DC;
- MECHANICAL:
  - MATING FORCE: 35N MAX.;
  - UNMATING FORCE: 5~35N ;
  - OPERATING LIFE: 1500 CYCLES MIN.;
- PLATING:
  - TERMINAL:
    - NI PLATING OVER ALL,
    - Tin PLATING ON SOLDER AREA,
    - Au G/Fu" ON CONTACT AREA;
  - SHELL: NI PLATING OVER ALL;
- ENVIRONMENTAL:
  - STORAGE TEMPERATURE RANGE: -40°C~+85°C;
  - OPERATION TEMPERATURE RANGE: -25°C~+70°C;

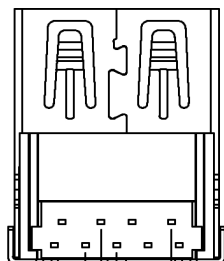
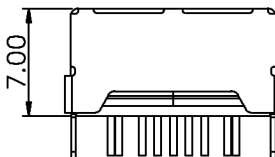
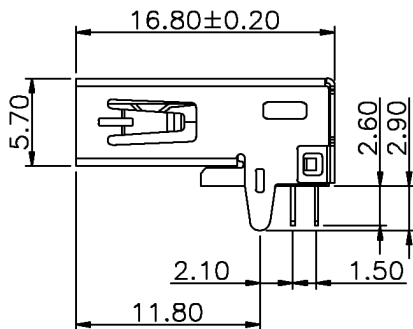
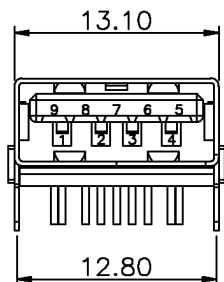
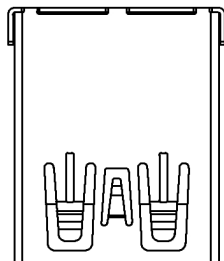

2\*1.00  
4\*2.00  
2\*3.50

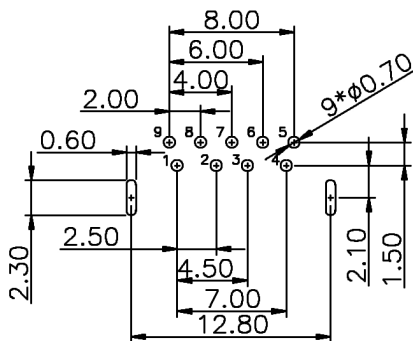

RECOMMENDER P.C.B. LAYOUT TOP VIEW  
(COMPONENT SIDE TOLERANCE±0.05)

深圳市金航标电子有限公司		WWW.BDS666.COM		
KH-3.0AF90ZJ-16.8		0755-83044319		
UNLESS OTHERWISE, GENERAL TOLERANCE: X.xxx ±0.10 X.xx ±0.20 X.x ±0.30	NAME:	3.0 A母90° 直脚平口		P/N: 09.03.02.004
	THIRD ANGLE PROJECTION	UNIT:	SCALE	SIZE:
ANGULAR: X.xxx° ±1° X.xx° ±3° X.x° ±5°	DRAWN:	MM	1:1	A4
	CHECKED:			1/1
				A1
				APPROVED: